

Varenummer: 2307080183
 Beskrivelse: E+G Mini mekanisk tæller
 DD50-AN-02.0-D-AR Orange

Mål

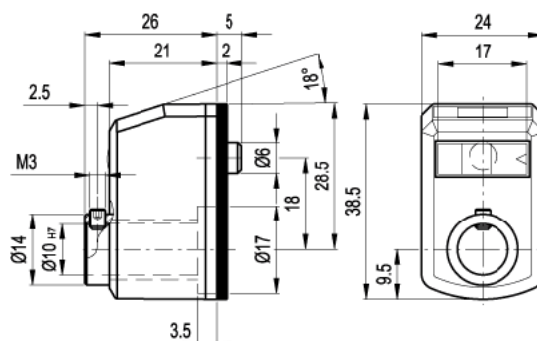













Table of the possible combinations								
Reading position	Pitch	Reading after one revolution				Speed (rpm)*	Direction of rotation	Colour
		0	1	0	1			
 AN vertical upper	1.0	01.0	0.10	010	1500		 AR orange RAL 2004	
 AR vertical lower	2.0	02.0	0.20	020	1250		 GR grey RAL 7035	
 FN front upper	4.0	04.0	0.40	040	625		 NR black RAL 7021	
 FR front lower	5.0	05.0	0.50	050	500			
	10	10.0	1.00	100	250			

01.0	Standard reading
0.10	Reading available on request (see 17. Annex)

D D 5 0 - FR - 0 1 0 - S - GR

* The maximum rotation speed (rpm) of the spindle reported in the table corresponds to a maximum rotation speed of 25,000 units per minute of the test roll on the right side of the counter. Rotational speed tests have been performed in our laboratory under standard operating conditions.

Betegnelse = Se mål på tegning